

# NS-206F/NSM-206F Series

Unmanaged 4-Port Industrial 10/100 Base-TX with Dual 100 Base-FX Fiber Switch

## Highlight Information ▶▶▶▶

NS-206F/NSM-206F Series



For NSM-206F Series



For NS-206F Series



NSM-206F Series



NS-206F Series



## ● Introduction

The NS-206F/NSM-206F series is a Unmanaged 4-Port Industrial 10/100 Base-TX with Dual 100 Base-FX Switch that secures data transmission by using fiber optic transmission to provide immunity from EMI/RFI interference. It is used Ethernet for transmitting a signal up to 2 km (6,600 ft), and is the perfect solution for applications where transmission must be protected from electrical exposure, surges, lightning or chemical corrosion.

The NS-206FT can extend your LAN in a daisy chain configuration. Please refer to Hardware. The Ethernet supports 10/100M auto negotiation feature and auto MDI/MDI-X function.

## ● Features

- Automatic MDI/MDI-X crossover for plug-and-play
- Each port supports both 10/100 Mbps speed auto negotiation
- Store-and-forward architecture
- Full duplex IEEE 802.3x and half duplex backpressure flow control
- 1.6 Gbps high performance memory bandwidth
- Frame buffer memory: 256 Kbit
- Integrated look-up engine with dedicated 1024 unicast MAC addresses
- Supports +10 V<sub>DC</sub> ~ +30 V<sub>DC</sub>
- Supports operating temperatures from 0 °C ~ +70 °C
- Din-Rail

## ● Specifications

Models	NS-206F Series	NSM-206F Series
<b>Technology</b>		
Standards	IEEE 802.3, 802.3u, 802.3x	
Processing Type	Store & forward, wire speed switching	
MAC Addresses	1024	
Memory Bandwidth	1.6 Gbps	
Frame Buffer Memory	256 Kbit	
Flow Control	IEEE 802.3x flow control, back pressure flow control	
<b>Interface</b>		
RJ-45 Ports	10/100 Base-TX auto negotiation speed, F/H duplex mode, and auto MDI/MDI-X connection	
Fiber Port	100 Base-FX	
LED Indicators	10/100M, Link/Act, Full duplex/Half duplex (Fiber Port)	
Ethernet Isolation	1500 V <sub>rms</sub> 1 minute	
Frame Ground for EMS Protection	Yes	
Multi Mode	Multi Mode Fiber Cables: 50/125, 62.5/125 or 100/140 μm	
	Distance: 2 km, (62.5/125 μm recommended) for full duplex	
	Wavelength: 1300 or 1310 nm	
	Min. TX Output: -20 dBm	
	Max. TX Output: -14 dBm	
Single Mode	RX Sensitivity: -34 ~ -31 dBm	
	Single Mode Fiber Cables: 8.3/125, 8.7/125, 9/125 or 10/125 μm	
	Distance: 15 km, (9/125 μm recommended) for full duplex	
	Wavelength: 1300 or 1310 nm	
	Min. TX Output: -15 dBm	
Ethernet Transmission Distance	Max. TX Output: -8 dBm	
	RX Sensitivity: -36 ~ -31 dBm	
	Ethernet: 2-pair UTP/STP Cat.3, 4, 5, EIA/TIA-568 100 Ω	
Fast Ethernet: 2-pair UTP/STP Cat. 5, EIA/TIA-568 100 Ω		
<b>Power</b>		
Input Voltage Range	+10 V <sub>DC</sub> ~ +30 V <sub>DC</sub> (Non-isolation)	+10 V <sub>DC</sub> ~ +30 V <sub>DC</sub> (Non-isolation) Redundant Inputs
Power Consumption	0.24 A @ 24 V <sub>DC</sub> , +/-5% arrowed with 100M Full duplex	
LED Indicator	Yes	
Protection	Power reverse polarity protection	
Frame Ground for EMS Protection	Yes	
<b>Mechanical</b>		
Casing	Plastic (Flammability UL 94V-0)	Metal (IP20 Protection)
Dimensions (W x L x H)	64 mm x 101 mm x 118 mm	73 mm x 105 mm x 132 mm
Installation	DIN-Rail	DIN-Rail or Wall Mounting
<b>Environmental</b>		
Operating Temperature	0 °C ~ +70 °C	
Storage Temperature	-20 °C ~ +85 °C	
Ambient Relative Humidity	10% ~ 90% RH, non-condensing	

## LED Functions

### NSM-206F Series LED Indicator Functions

LED	Color	Description
PWR_OK	Red On	Core Power is OK
	Red Off	Core Power is Off
Full for P0	Green On	Link/Act
	Green Off	Not Networking
Link for P1	Yellow On	Link/Act
	Yellow Off	Not Networking
Ethernet Port (P2 ~ P5)	Green On	Link/Act
	Green Off	Not Networking
	Yellow On	Link to 100 Mbps
	Yellow Off	Link to 10 Mbps
PWR2	Green On	Power is being supplied to power input PWR2
	Green Off	Power is not being supplied to power input PWR2
	Yellow On	Power is being supplied to power input PWR1
PWR1	Yellow Off	Power is not being supplied to power input PWR1
	Red On	Power is not being supplied to power input PWR1 and PWR2
FAULT	Red On	Power is not being supplied to power input PWR1 and PWR2
	Red Off	Power is being supplied to power input PWR1 and PWR2

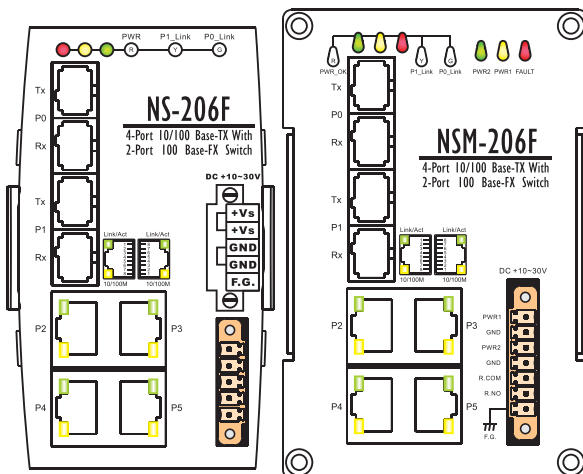

### NS-206F Series LED Indicator Functions

LED	Color	Description
Power	Red On	Power is On
	Red Off	Power is Off
Fiber Port (P0)	Green On	Link/Act
	Green Off	Not Networking
Fiber Port (P1)	Yellow On	Link/Act
	Yellow Off	Not Networking
Ethernet Port (P2 ~ P5)	Green On	Link/Act
	Green Off	Not Networking
	Yellow On	Link to 100 Mbps
	Yellow Off	Link to 10 Mbps

## Applications

### Fiber Daisy Chain Configuration

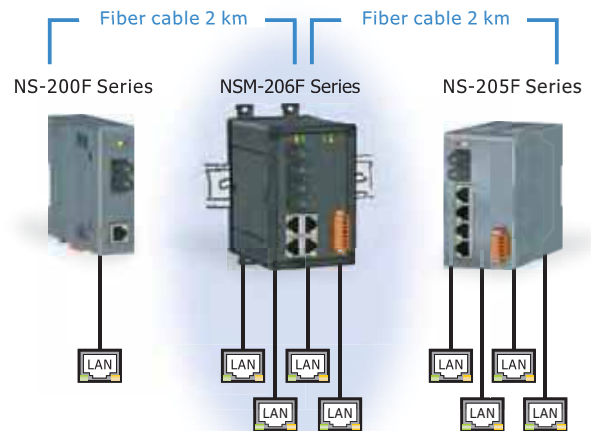

## Appearance

### NSM-206F Series

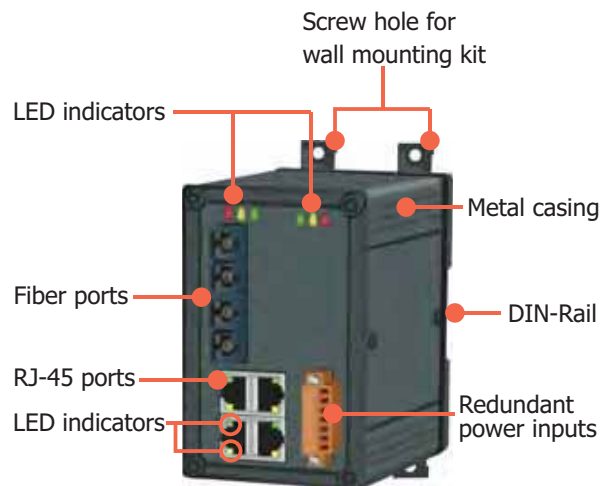

### NS-206F Series

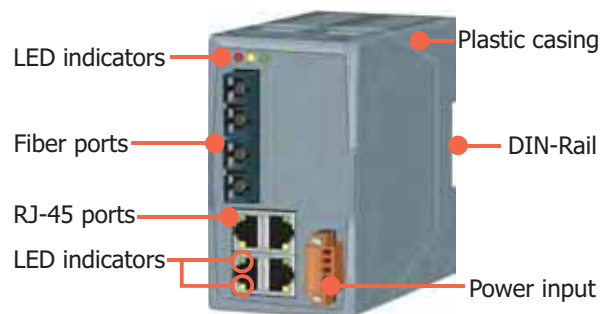

# High Reliability Industrial Ethernet Switch for Rugged Environment

## ● Dimensions (Unit: mm)

### NSM-206F Series

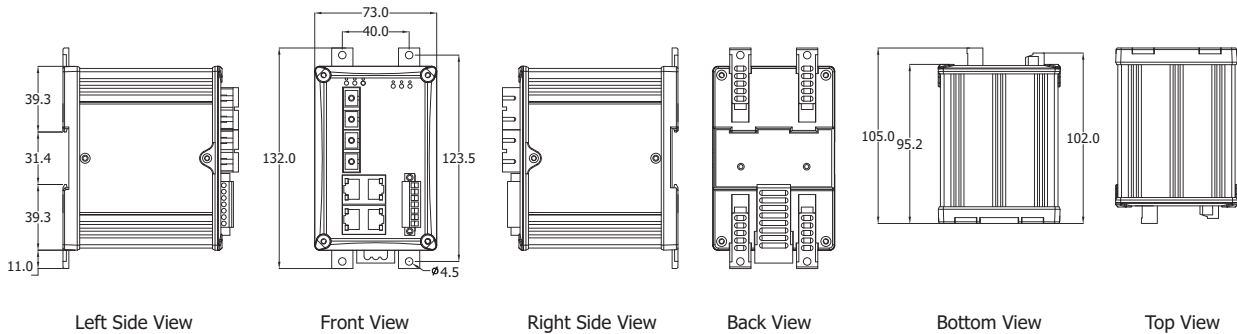

### NS-206F Series

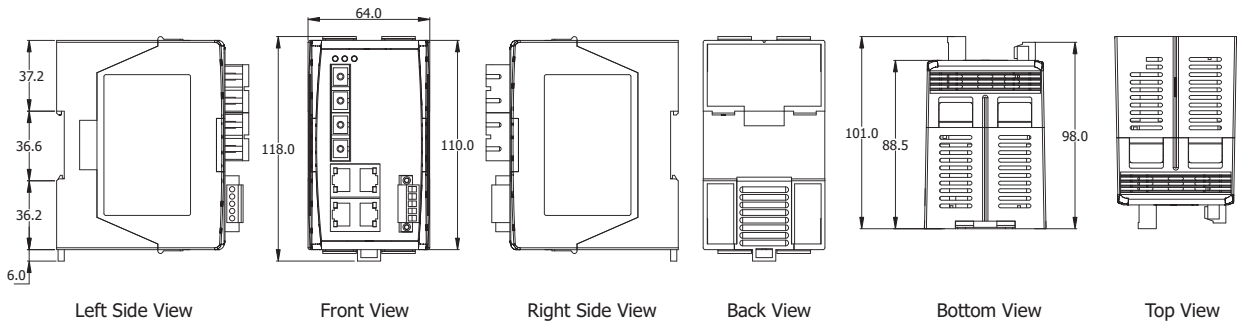

## ● Ordering Information

<p style="text-align: center;"><b>NS M -206 A F [ ] [ ] - 4 0 - [ ]</b></p> <p><b>M:</b> Metal    <b>A:</b> Power Input +12 V<sub>DC</sub> ~ +48 V<sub>DC</sub></p> <p style="text-align: right;">Single Mode Distance <b>40:</b> 40 km Standard Models: 15 km</p>		
Ordering Code Definition	Fiber Port Connector	Operating Temperature
	<p><b>T:</b> Multi Mode ST Connector</p> <p><b>C:</b> Multi Mode SC Connector</p> <p><b>CS:</b> Single Mode SC Connector</p>	<p><b>T:</b> Operating Temp: -40 °C ~ +75 °C</p> <p>Standard Models: 0 °C ~ +70 °C</p>
Models	<p>Art. No. 115836 NS-206FT</p> <p>Art. No. 115837 NS-206FC</p> <p>Art. No. 114526 NS-206FCS</p> <p>Art. No. 115843 NSM-206FT</p> <p>Art. No. 115841 NSM-206FC</p> <p>Art. No. 115842 NSM-206FCS</p>	

## ● Accessories

MDR-20-24	24V/1A, 24 W Power Supply with DIN-Rail Mounting
KWM020-1824F	24V/0.75A, 18 W Power Supply
DIN-KA52F	24V/1.04A, 25 W Power Supply with DIN-Rail Mounting

## 75W Single Output Industrial DIN Rail Power Supply

## DR-75 series



### ■ Features :

- Universal AC input/Full range
- Protections: Short circuit/Over load/Over voltage/Over temperature
- Cooling by free air convection
- Can be installed on DIN rail TS-35/7.5 or 15
- UL 508(industrial control equipment)approved
- LED indicator for power on
- 100% full load burn-in test
- Fix switching frequency at 50KHz



### SPECIFICATION

MODEL	DR-75-12	DR-75-24	DR-75-48	
OUTPUT	DC VOLTAGE	12V	24V	48V
	RATED CURRENT	6.3A	3.2A	1.6A
	CURRENT RANGE	0 ~ 6.3A	0 ~ 3.2A	0 ~ 1.6A
	RATED POWER	76W	76.8W	76.8W
	RIPPLE & NOISE (max.) Note.2	100mVp-p	150mVp-p	240mVp-p
	VOLTAGE ADJ. RANGE	12 ~ 14V	24 ~ 28V	48 ~ 53V
	VOLTAGE TOLERANCE Note.3	±2.0%	±1.0%	±1.0%
	LINE REGULATION	±0.5%	±0.5%	±0.5%
	LOAD REGULATION	±1.0%	±1.0%	±1.0%
	SETUP, RISE TIME	1000ms, 60ms/230VAC    1800ms, 60ms/115VAC at full load		
HOLD TIME (Typ.)	60ms/230VAC    12ms/115VAC at full load			
INPUT	VOLTAGE RANGE	85 ~ 264VAC    120 ~ 370VDC		
	FREQUENCY RANGE	47 ~ 63Hz		
	EFFICIENCY (Typ.)	76%	80%	81%
	AC CURRENT (Typ.)	1.6A/115V    0.96A/230V		
	INRUSH CURRENT (Typ.)	COLD START 20A/115VAC    40A/230VAC		
LEAKAGE CURRENT	<1mA/ 240VAC			
PROTECTION	OVER LOAD	105 ~ 150% rated output power Protection type : Constant current limiting, recovers automatically after fault condition is removed		
	OVER VOLTAGE	15 ~ 16.5V	29 ~ 34V	58 ~ 65V
	OVER TEMPERATURE	85°C ±5°C (TSW1) Detect on heat sink of power transistor Protection type : Shut down o/p voltage, recovers automatically after temperature goes down		
ENVIRONMENT	WORKING TEMP.	-10 ~ +60°C (Refer to output load derating curve)		
	WORKING HUMIDITY	20 ~ 90% RH non-condensing		
	STORAGE TEMP., HUMIDITY	-20 ~ +85°C, 10 ~ 95% RH		
	TEMP. COEFFICIENT	±0.03%/°C (0 ~ 50°C)		
	VIBRATION	10 ~ 500Hz, 2G 10min./1cycle, period for 60min. each along X, Y, Z axes		
SAFETY & EMC (Note 4)	SAFETY STANDARDS	UL508, TUV EN60950-1 Approved		
	WITHSTAND VOLTAGE	I/P-O/P:3KVAC    I/P-FG:1.5KVAC    O/P-FG:0.5KVAC		
	ISOLATION RESISTANCE	I/P-O/P, I/P-FG, O/P-FG:100M Ohms/500VDC		
	EMI CONDUCTION & RADIATION	Compliance to EN55011, EN55022 (CISPR22) Class B		
	HARMONIC CURRENT	Compliance to EN61000-3-2, -3		
EMS IMMUNITY	Compliance to EN61000-4-2, 3, 4, 5, 6, 8, 11, ENV50204, EN55024, EN61000-6-2 (EN50082-2) Heavy industry level, criteria A			
OTHERS	MTBF	123.1K hrs min.    MIL-HDBK-217F (25°C)		
	DIMENSION	55.5*125.2*100mm (W*H*D)		
	PACKING	0.6Kg; 20pcs/13Kg/1.1CUFT		
NOTE	<ol style="list-style-type: none"> <li>1. All parameters NOT specially mentioned are measured at 230VAC input, rated load and 25°C of ambient temperature.</li> <li>2. Ripple &amp; noise are measured at 20MHz of bandwidth by using a 12" twisted pair-wire terminated with a 0.1uf &amp; 47uf parallel capacitor.</li> <li>3. Tolerance : includes set up tolerance, line regulation and load regulation.</li> <li>4. The power supply is considered a component which will be installed into a final equipment. The final equipment must be re-confirmed that it still meets EMC directives.</li> </ol>			

# 75W Single Output Industrial DIN Rail Power Supply

# DR-75 series

## Mechanical Specification

Case No. 923 Unit:mm

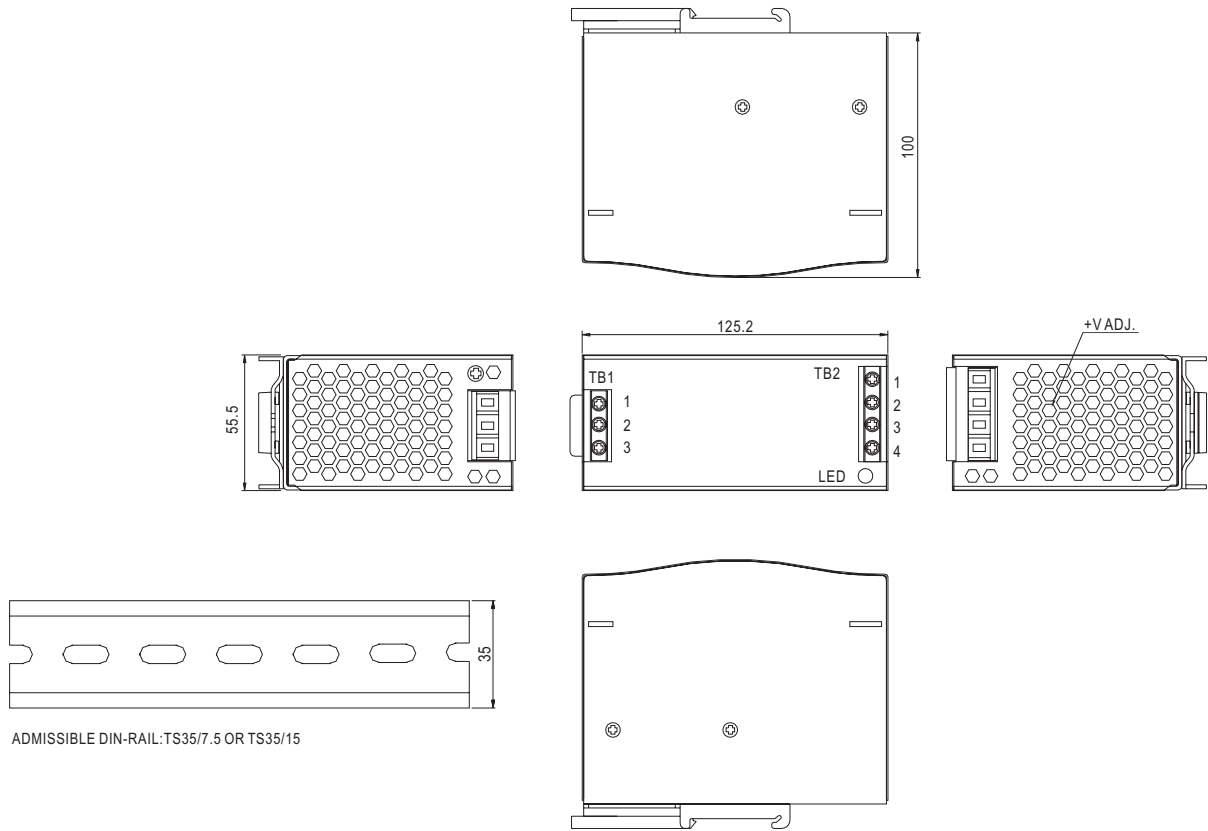

ADMISSIBLE DIN-RAIL: TS35/7.5 OR TS35/15

Terminal Pin. No Assignment (TB1)

Pin No.	Assignment
1	FG ⊕
2	AC/N(DC+)
3	AC/L(DC-)

Terminal Pin. No Assignment (TB2)

Pin No.	Assignment
1,2	DC OUTPUT +V
3,4	DC OUTPUT -V

## Output Derating

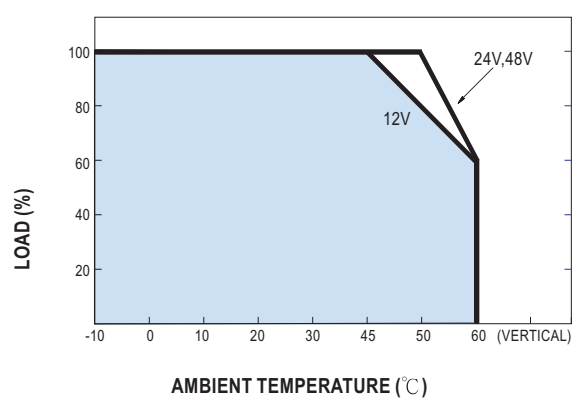

## Output Derating Vs Input Voltage

